



Energy research Centre of the Netherlands

Intelligent Energy  Europe

# Overview and Perspectives of Fuel Cell Technologies and Regional Market Developments

Gerard Kraaij

Workshop Coimbra, 27 May 2008



## Outline

- Hydrogen and fuel cells
- Regional markets
- RES-FC household systems

## Basics on hydrogen and fuel cells

- Hydrogen is an energy carrier
  - Needs to be produced (from hydrocarbons or water, using heat and/or electricity) *Presentation Thorsteinn Sigfusson*
  - Needs to be converted (fuel cell, internal combustion engine, gasturbine, burner)
- Fuel Cell is a conversion technology
  - Needs a fuel (hydrogen, syngas or hydrocarbon)
  - Produces electricity and heat
- Several types of fuel cells exist. Not all fuel cells need hydrogen, and to use hydrogen you do not necessarily need a fuel cell
- Fuel cells: most efficient way to convert hydrogen into electricity at small scale
- Efficiency of fuel cells is independent of scale and fuel cells have high part load efficiency (unlike ICE and gasturbine)

## Fuel cell: Basic principles

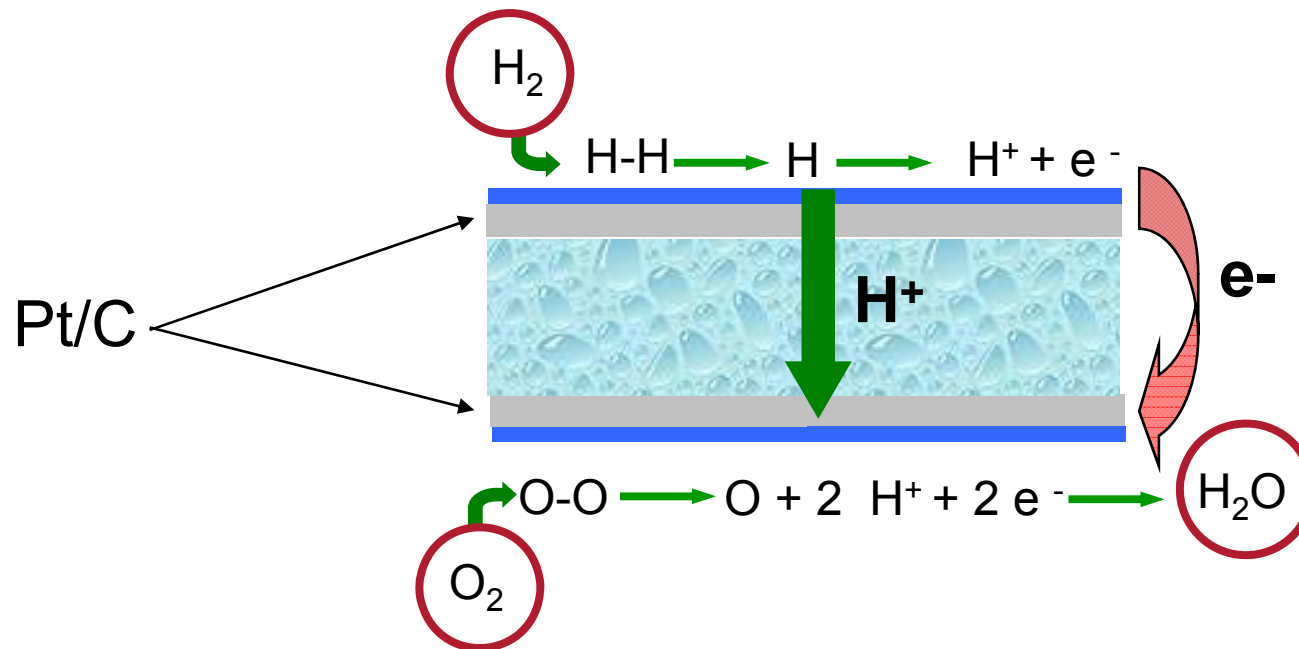

Overall reaction:  $2 H_2 + O_2 \rightarrow 2 H_2O + \text{electricity} + \text{heat}$

## Typical fuel cell characteristics

Efficiency =  $\frac{\text{cell voltage}}{1.23 \text{ V (LHV)}}$   
 $\frac{\text{cell voltage}}{1.48 \text{ V (HHV)}}$

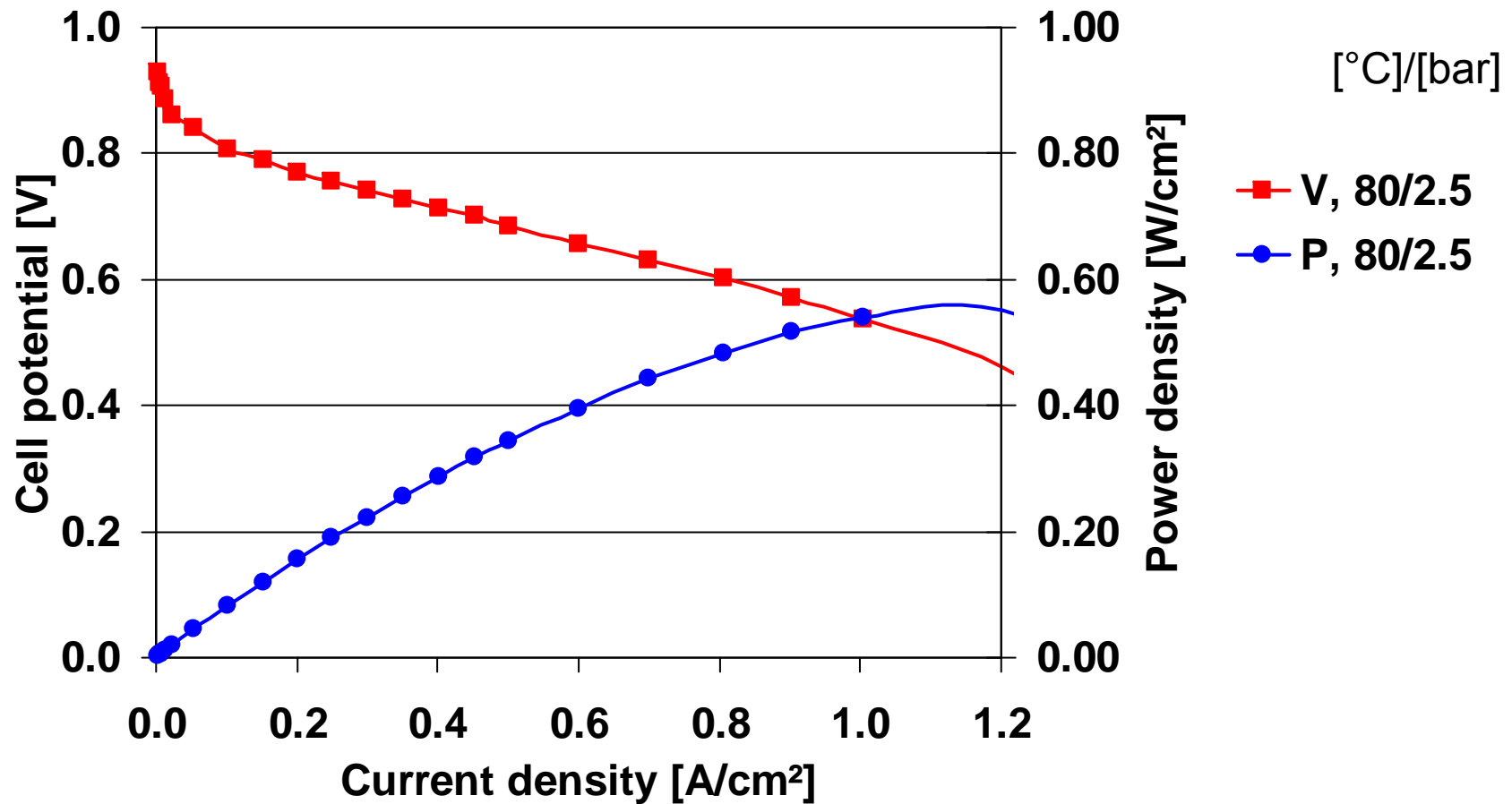

## Basics of a (PEM) fuel cell

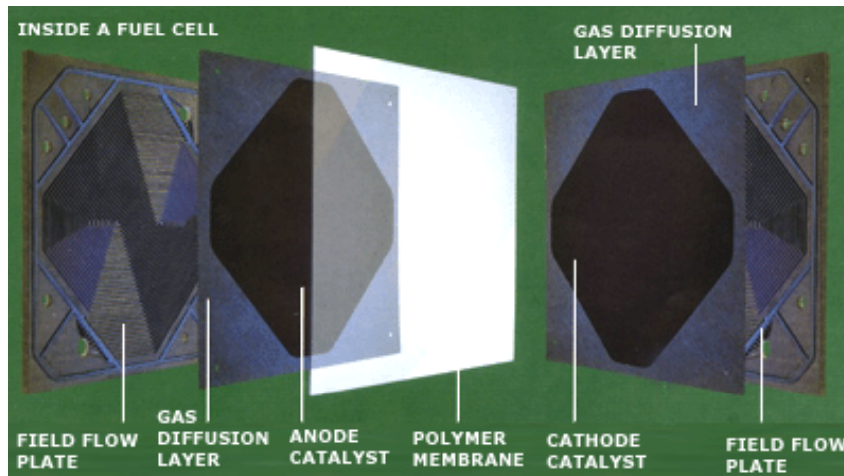

Fuel cell and flow or separator plates

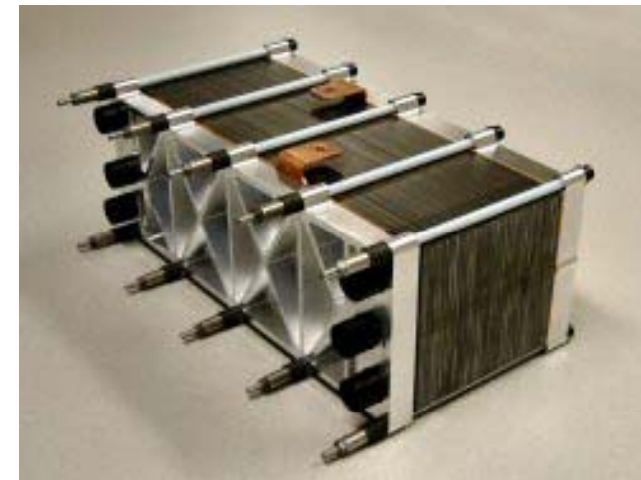

Stack of fuel cells

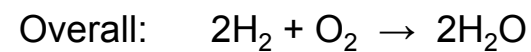
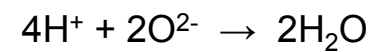
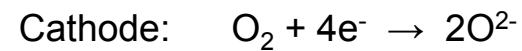
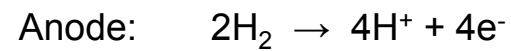
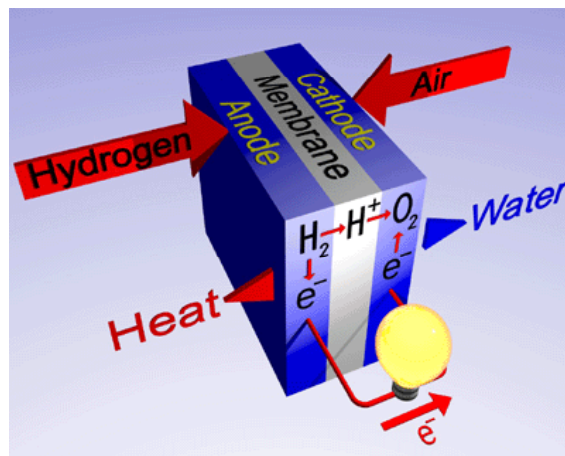

## Fuel cell system and residential application

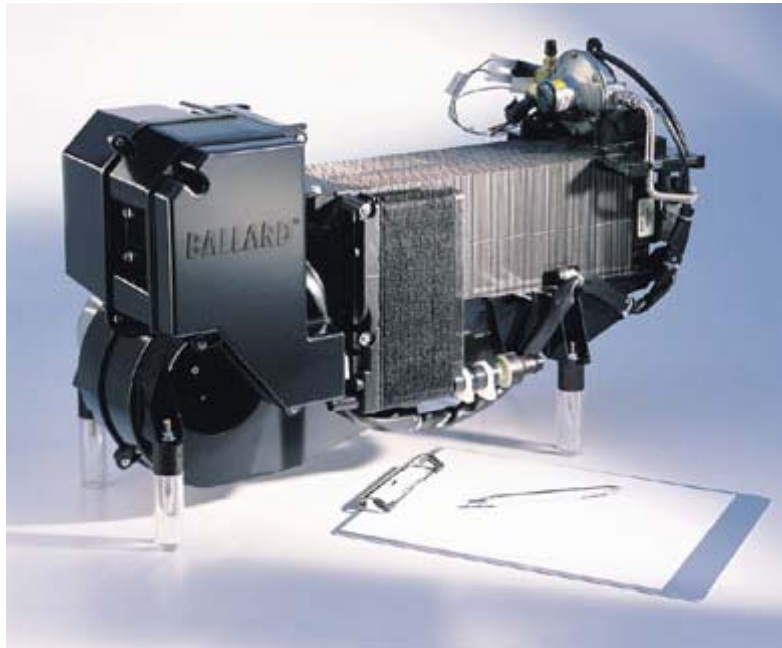

Aggregated market:

- PEM fuel cell
- Operating on H<sub>2</sub>
- 0.5-1 kW<sub>el</sub>
- New houses

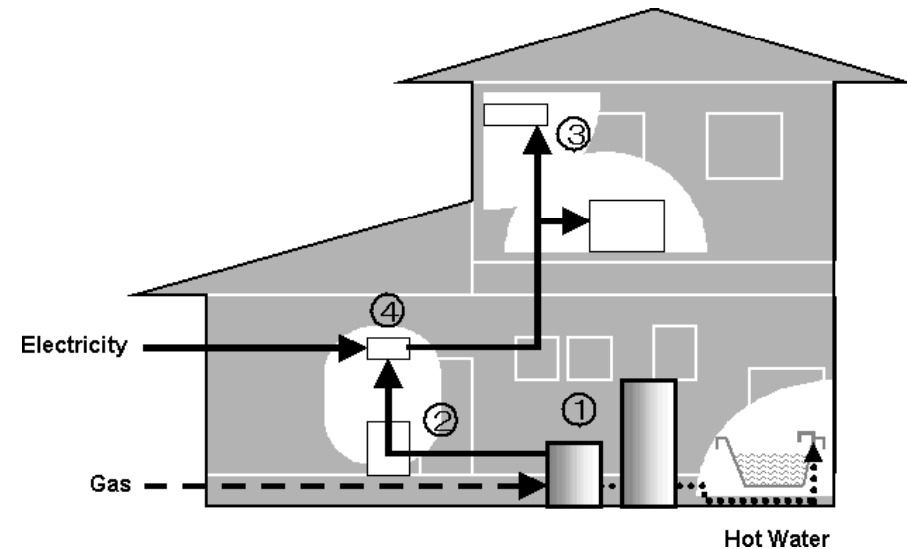

*Presentation Jesper Themsen*

## Fuel cell types

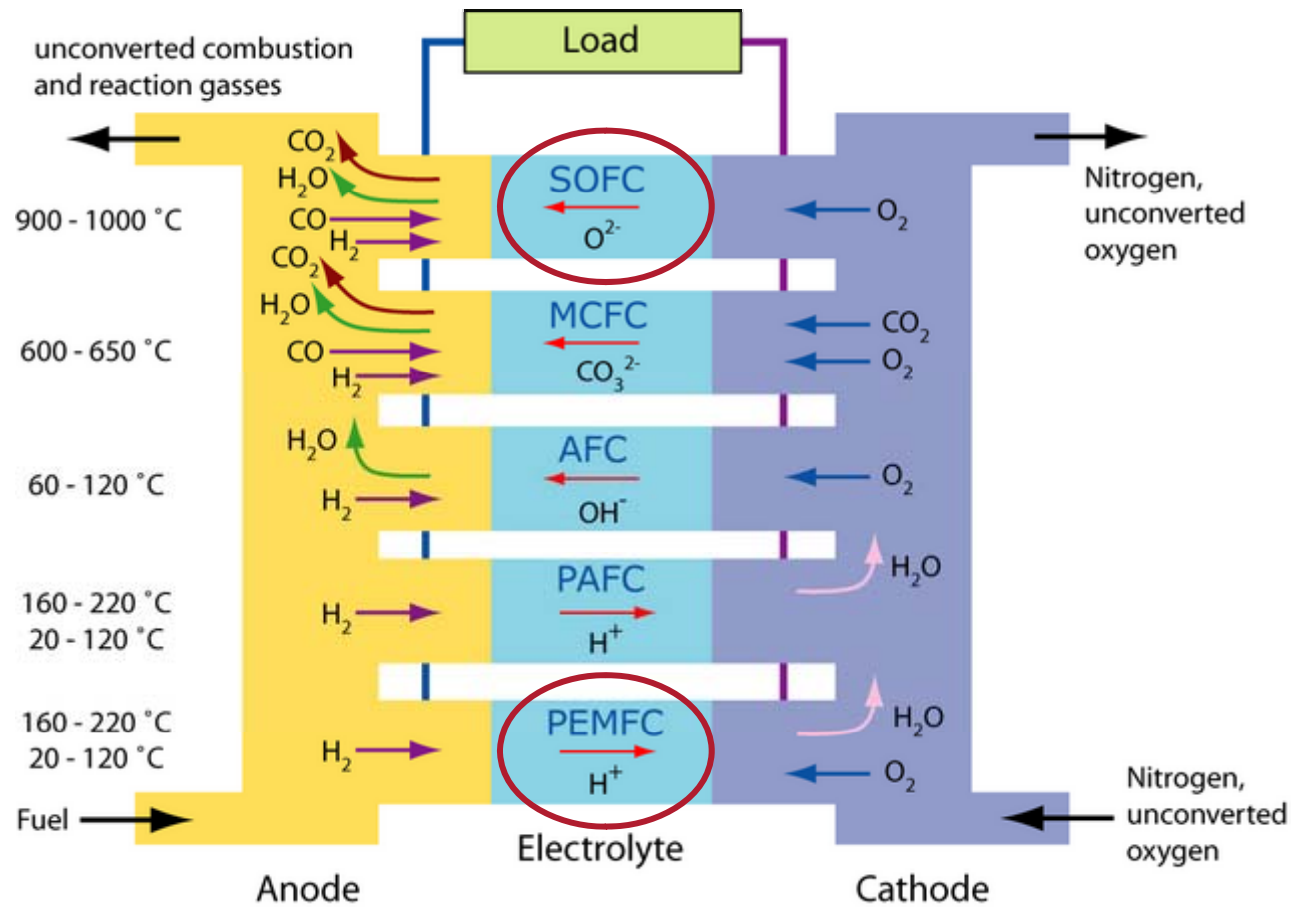

## Residential

1 kW<sub>el</sub> Fuel Cooling

$\eta_e = 50\%$  CH<sub>4</sub> Process Gas  
 $\eta_{th} = 40\%$  Gas

$\eta_e = 50\%$  H<sub>2</sub> Water  
 $\eta_{th} = 40\%$  NG\* reforming

## Why hydrogen with fuel cells

- Reduction of CO<sub>2</sub> emissions
  - Additional way to implement renewables
  - Production from fossil sources with CCS
  - Fuel switch and efficiency improvement

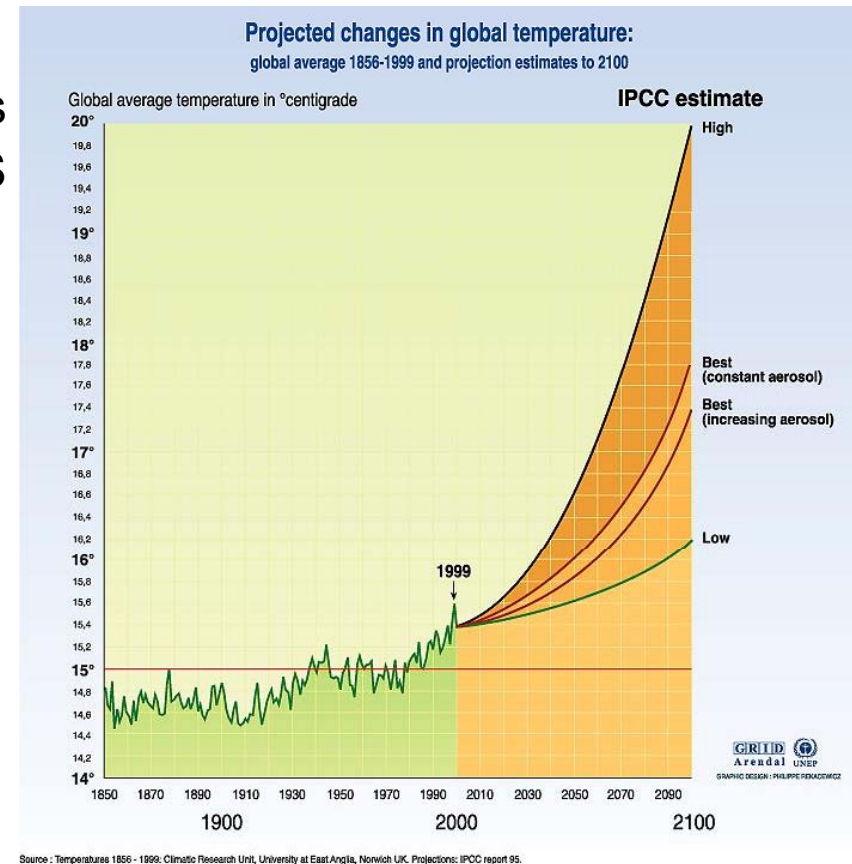
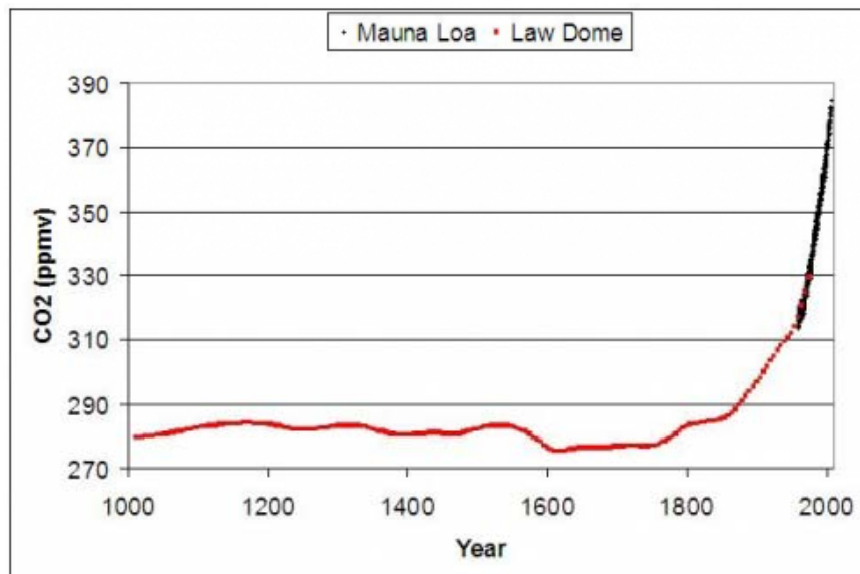

## RES-FCHS and regions considered

Biogas as renewable energy source

- Jutland, Denmark.
- Baden-Württemberg, Germany.

Biomass and Wind as renewable energy source

- Jutland, Denmark.
- Baden-Württemberg, Germany.
- Reykjavik, Iceland.

Wind as renewable energy source

- Jutland, Denmark.
- Schleswig-Holstein, Germany.
- Friesland, the Netherlands.
- Navarra, Spain.
- Coimbra, Portugal.



## Regional market information

PEMFC = residential CHP system on H<sub>2</sub>

Favourable perspectives:

- High electricity prices
  - Household cost for heat and electricity
  - Feed-in tariffs
  - Household energy system demand
- Low hydrogen prices
  - Concepts for renewable hydrogen

*Presentation Claus Torbensen*

## Electricity prices consumers EU-25 (2007/S1)

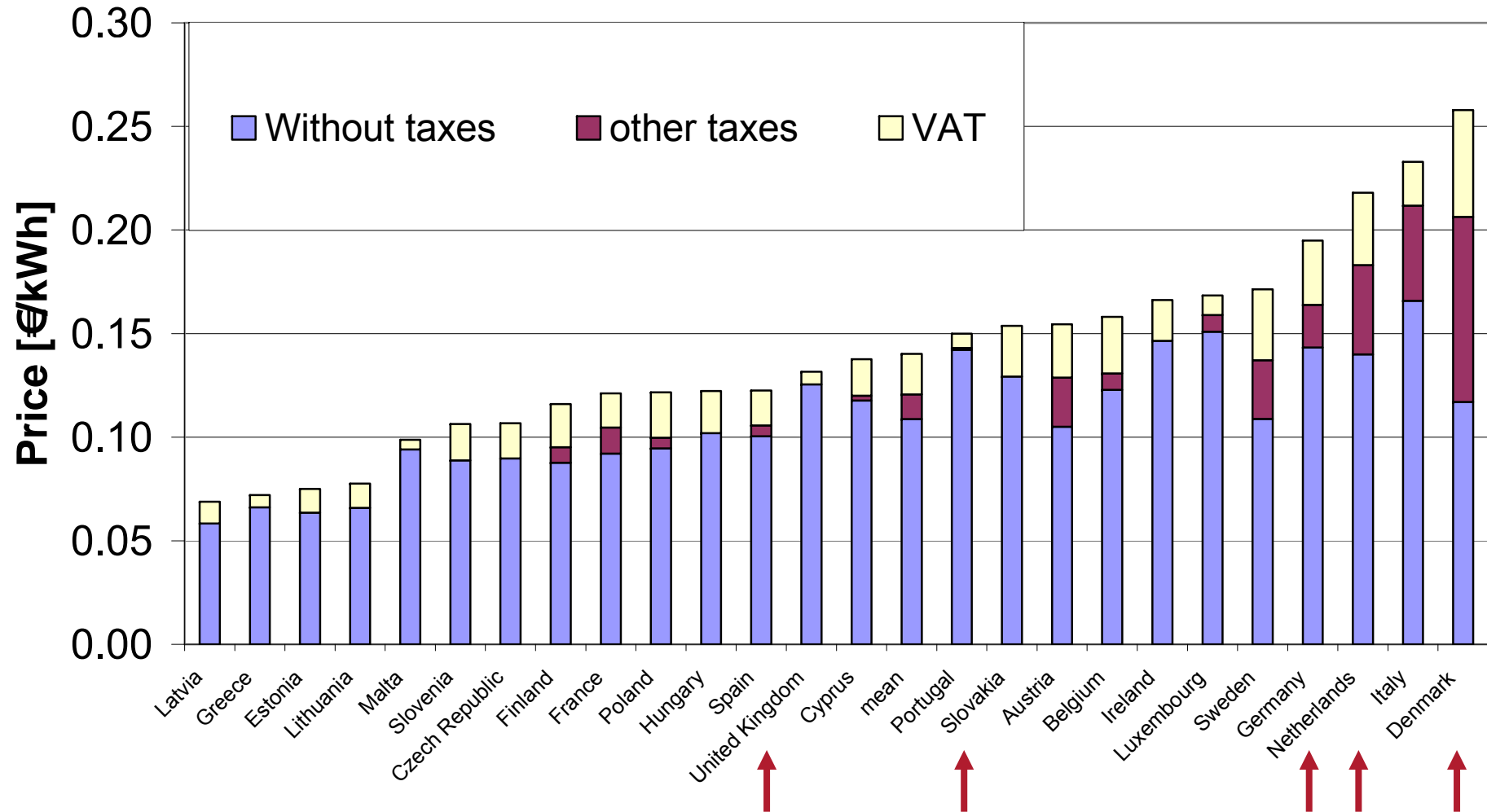

## Residential load duration curve for 3500 kWh/yr

Characteristic Powerloadcurve Household

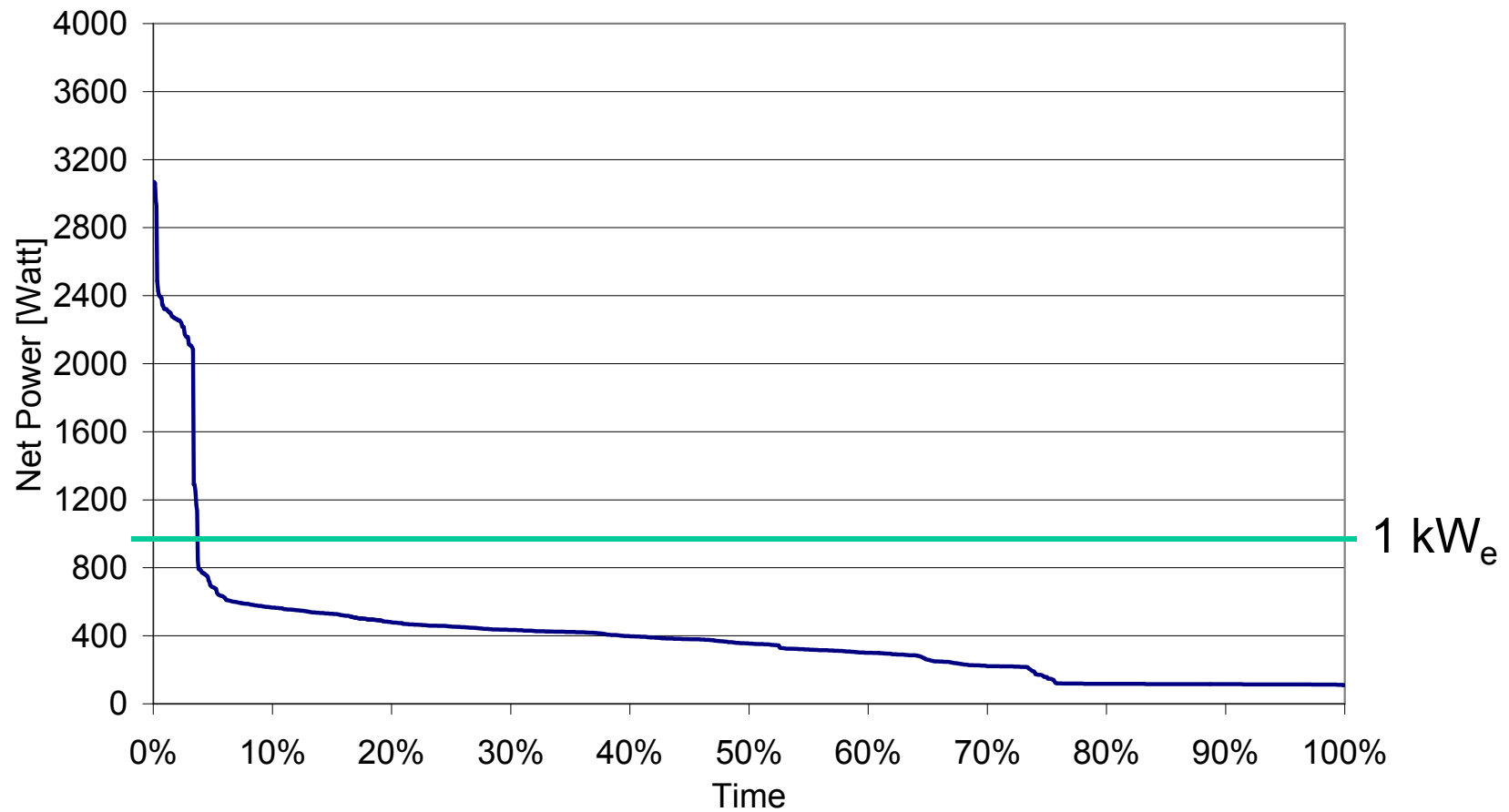

## Biogas as renewable energy source

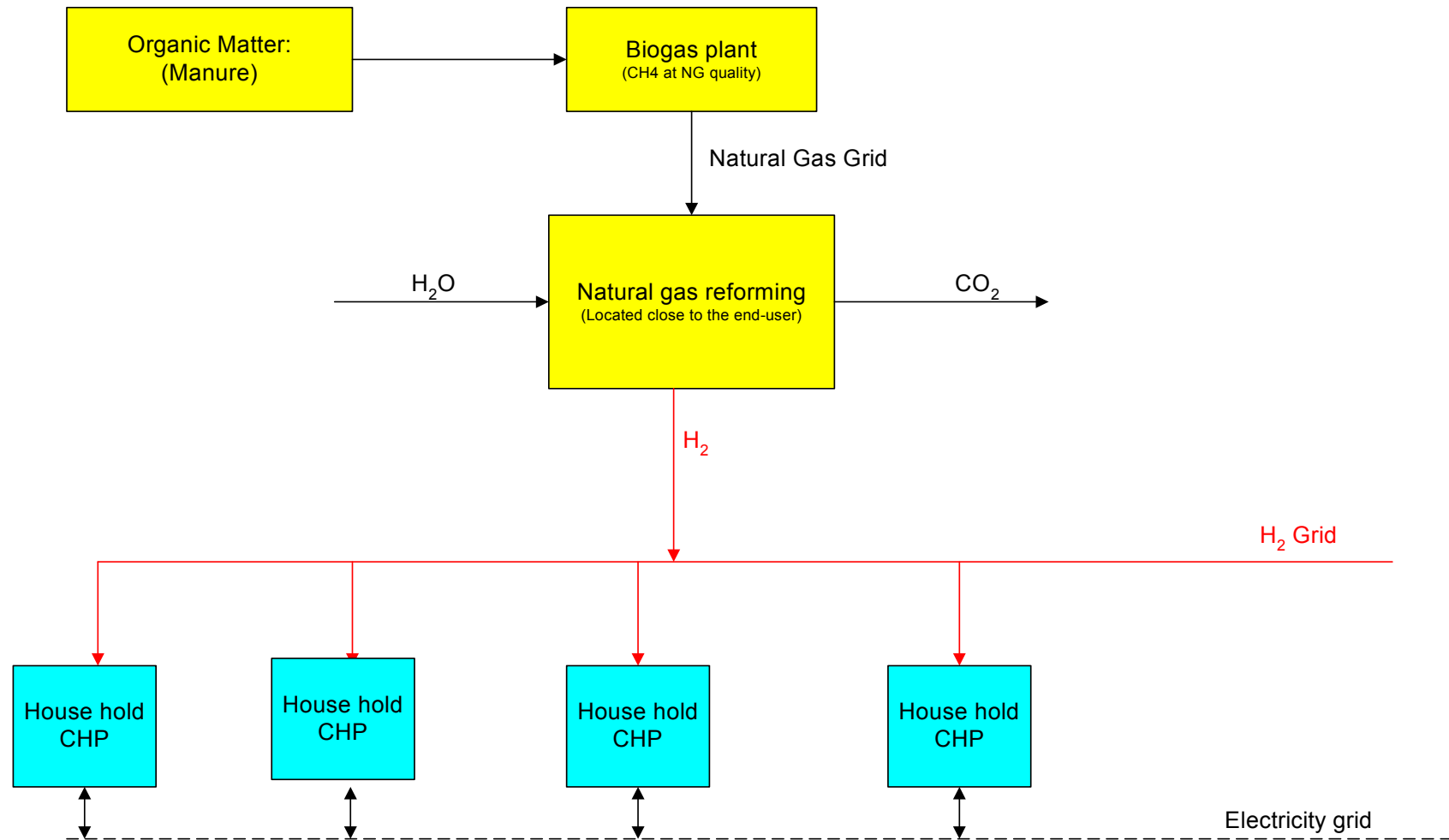

## Biogas as renewable energy source

Biogas can be cleaned and upgraded to NG quality at 4-5 €/m<sup>3</sup>

NG can be reformed and purified to H<sub>2</sub> (75% efficiency)

H<sub>2</sub> to be fed to a PEMFC

Alternatively: PEMFC stack on reformat gas

However

Biogas can be used directly with MCFC after cleaning

Simpler and more economical process

Size 250 kW => not for household application

Industrial use of heat or heating grid instead of hydrogen

## Biogas as renewable energy source

European electricity production from biogas.

Germany            5564 GWh  
Denmark            274 GWh

	2004	2005
Germany	4 414,0	5 564,0
United Kingdom	4 383,0	4 690,0
Italy	1 170,3	1 313,1
Spain	824,7	879,4
France	444,0	460,0
Netherlands	282,0	286,0
Denmark	265,0	274,0
Belgium	231,9	236,9
Greece	179,0	179,0
Poland	155,0	175,1
Czech Republic	138,8	160,9
Ireland	101,0	122,0
Austria	57,7	57,7
Portugal	14,6	34,4
Slovenia	30,3	32,2
Sweden	61,6	53,4
Luxembourg	20,3	27,1
Hungary	23,0	25,0
Finland	21,7	21,7
Slovakia	2,0	2,0
<b>Total EU</b>	<b>12 819,9</b>	<b>14 593,8</b>

Source: EurObserv'ER 2006

# Wind as renewable energy source

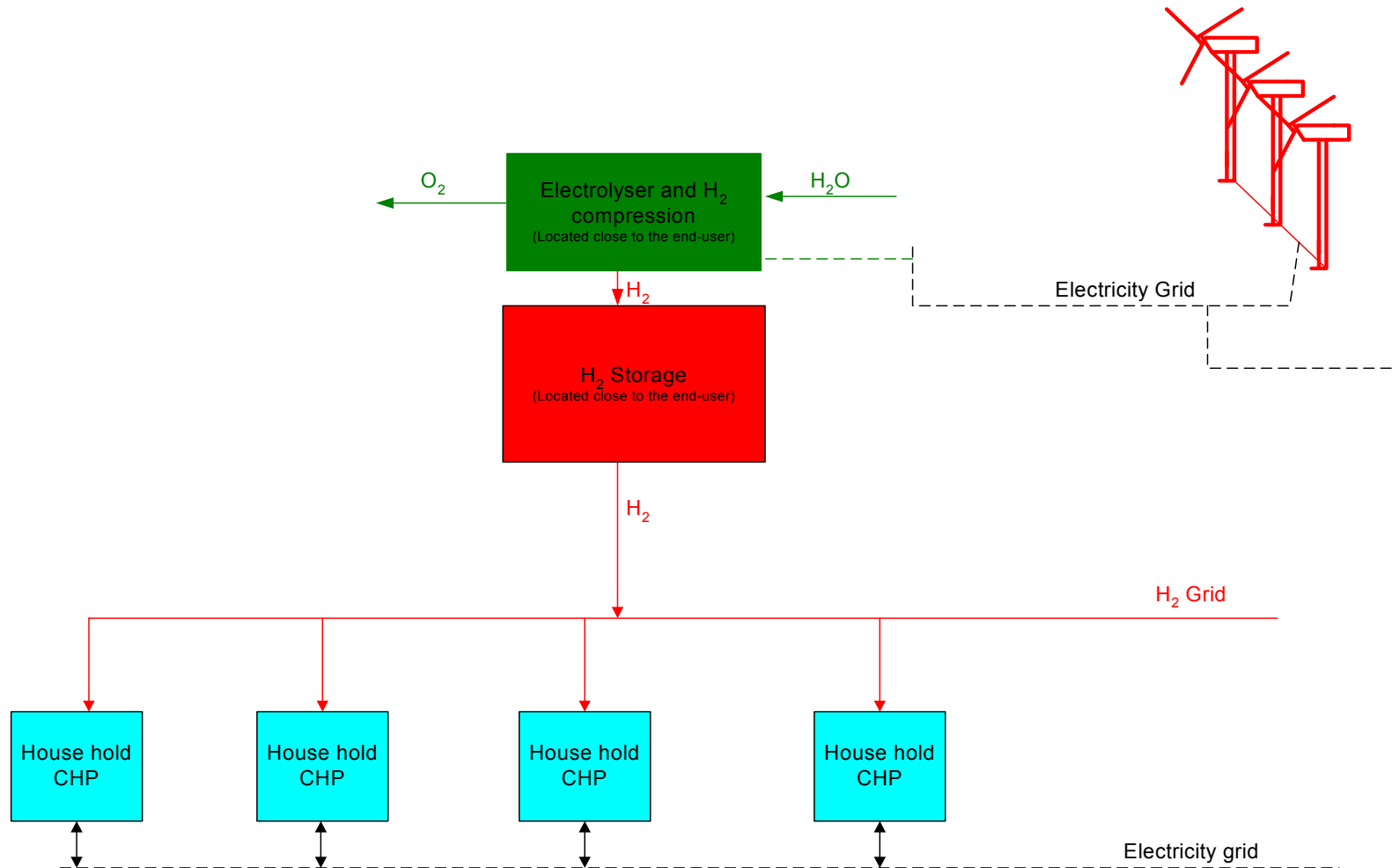

## Wind as renewable energy source

Regions with network integration questions (DK;DE;ES)

Stochastic wind production

Seasonal/daily hydrogen storage

Low load factor; either electrolysis **or** fuel cell operation

Round trip electrical efficiency 31%

- Electrolyser 67% (LHV) (= 80% HHV)
- Compression/transport/storage 90%
- Fuel cell system 50% (LHV) (=42% HHV)

Electrolysers

*Presentation Lars Yde*

## Wind as renewable energy source

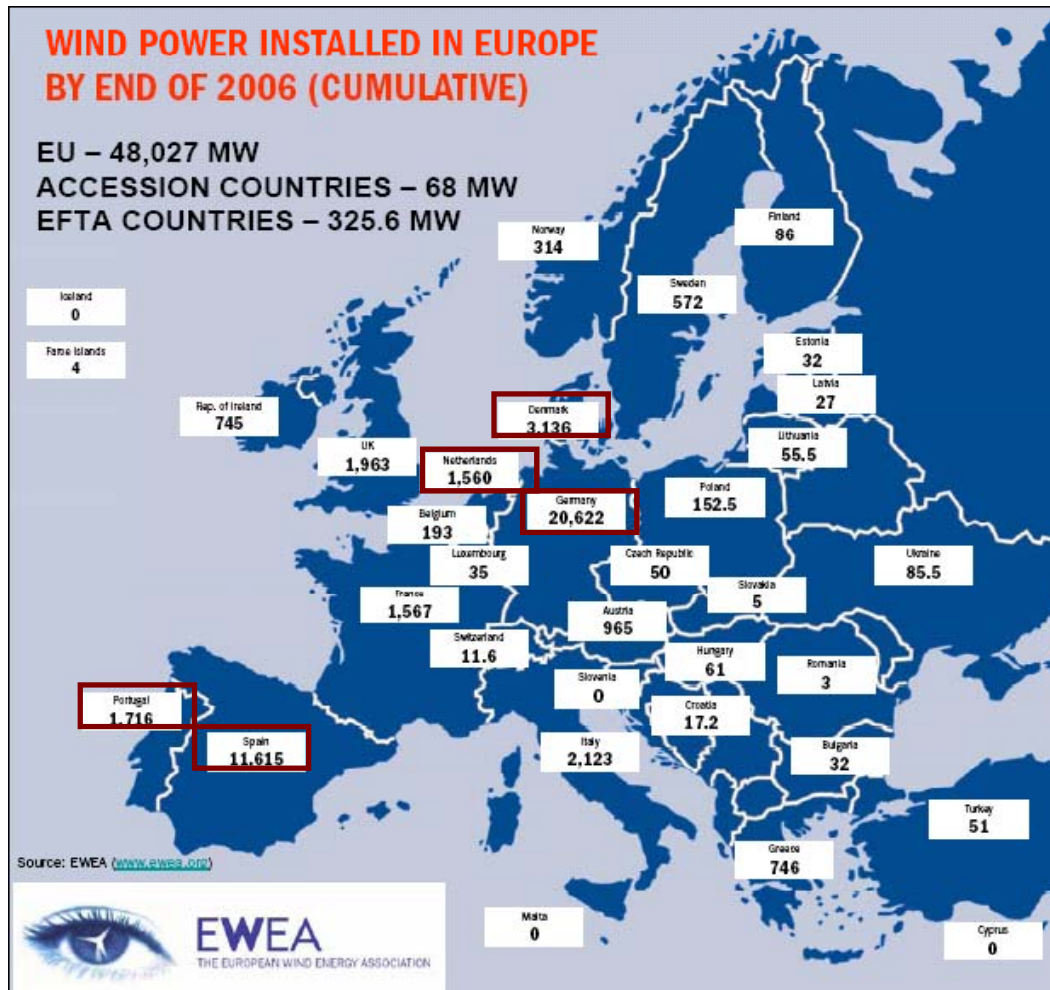

Germany	20.6 GW
Spain	11.6 GW
Denmark	3.1 GW
Portugal	1.7 GW
Netherlands	1.6 GW

## Biomass and Wind as renewable energy source

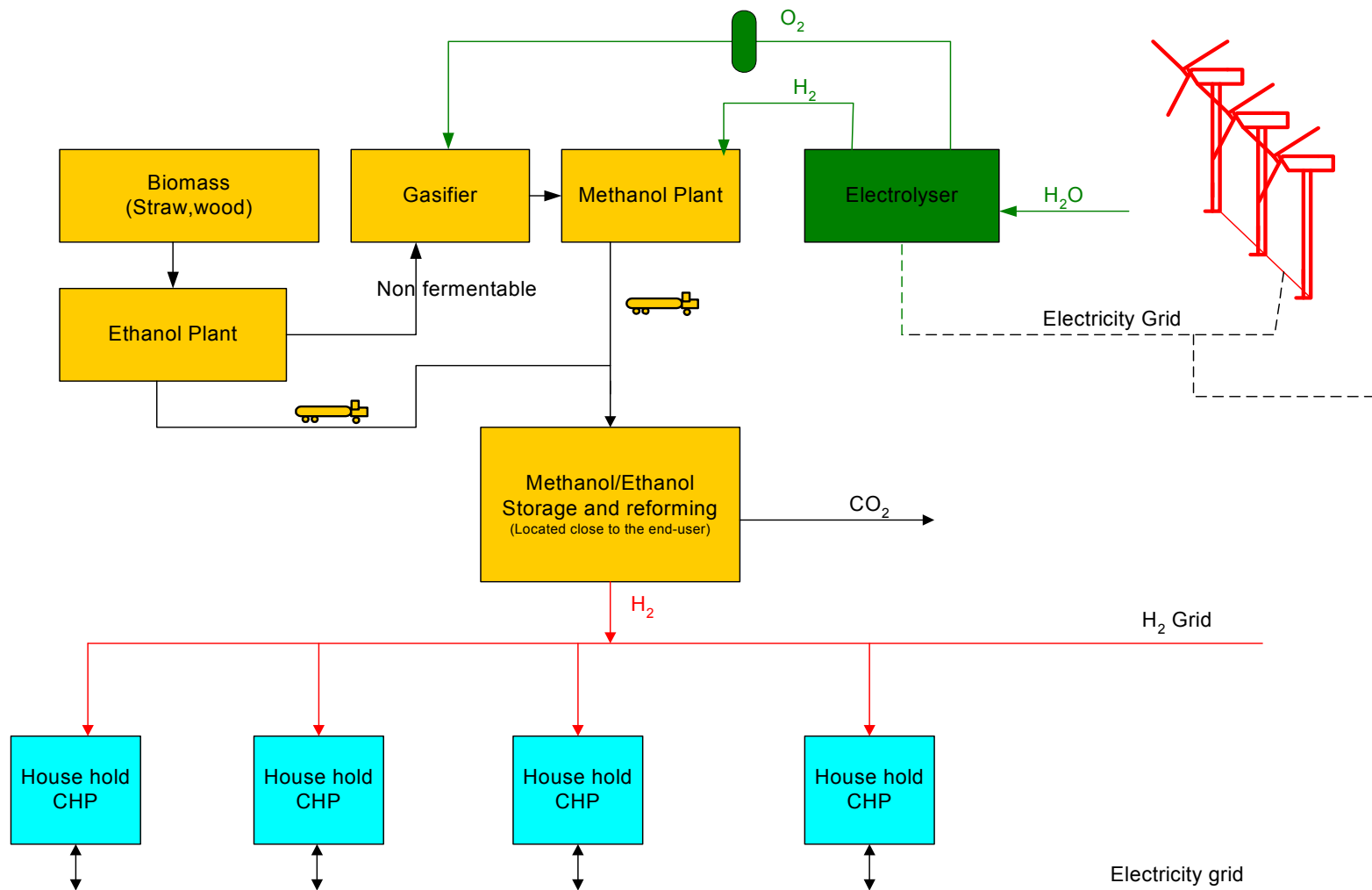

## Biomass and Wind as renewable energy source

Transportation of (m)ethanol to households in more remote areas.

Biomass to (m)ethanol still in development scale;

Estimated future fuel price 17 €/GJ

Methanol from NG is standard process

Market fuel price 12.5 €/GJ

Methanol reforming and H<sub>2</sub> purification is possible (75% efficiency)

## FCHS initiatives

### Denmark

- Herning (200 units).
- Nolsoy, Sonderborg and Nakskov (200 units).

### Germany

- 450 units in 2010.
- 2250 units in 2012.

### Netherlands

- 10.000 SOFC units/yr from 2009 (if specs are met).

### Spain; Portugal; Iceland

- Small scale demonstrations.

## Favourable policy framework

### Existing:

- EU target of 30 % GHG reduction in 2020
- Public awareness of climate change
- RES- subsidies and support

### Required:

- Subsidy for fuel cell or  $\mu$ -CHP electricity
- Legislation for H<sub>2</sub>: Preliminary NEN-EN 50465

## Other issues

### Barriers:

- Cost of fuel cell residential system
- Low heat demand in Spain/Portugal

### Other developments:

- H<sub>2</sub> use for transport
- Competing technologies
  - Solar heating in Spain and Portugal
  - Geothermal energy in Iceland
  - MCFC (Biogas)
  - Stirling (on NG)
  - SOFC (on NG)

## Acknowledgement

Intelligent Energy Europe has supported this work  
under contract EIE/05/214/SI2.420237



Energy research Centre of the Netherlands

Intelligent Energy  Europe

**Thank you for your attention!**

